

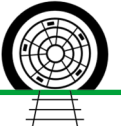

2023

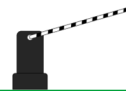

# Produktbroschüre / *Product brochure*





## Systeme / Systems

Rüchfahrssystem / <i>Rear View System</i>	3
Gabelstapler-System / <i>Forklift system</i>	4
Glieder- & Sattelzug / <i>Semi Trailer</i>	5
SplitUnit System (Funk/ <i>Wireless</i> & Mastkabel/ <i>Mast cable</i> )	6
Splitkabel / <i>Split cable</i>	7
SplitUnit	8
QuadUnit	8
QuadUnit(Funk/ <i>Wireless</i> & Mastkabel/ <i>Mast cable</i> )	9
DVR - Videorekorder / <i>Video recorder</i>	10
Funksystem / <i>Wireless System</i>	11
Rundumsichtsystem / <i>Birdview</i>	12

## Produkte / Products

Monitor	14
Kameras / <i>Cameras</i>	15
Steuereinheit / <i>Control Unit</i>	16
Personenerkennung / <i>Pedestrian Detection</i>	17
PAL Kamera / <i>PAL Camera</i>	18
Funksystem / <i>Wireless System</i> (ArkPack Akku)	19
Rundumsichtsystem / <i>Birdview</i>	20
DVR - Videorekorder / <i>Video recorder</i>	21
Kabel / <i>Cables</i>	22
Stecker / <i>Connector</i>	27
Zubehör / <i>Accessories</i>	28
FAQ	29
Links	32



## Rückfahrssystem 7" Monitor FHD / *Rear View System 7" Monitor FHD*



Artikelnummer/ <i>Item number</i>	Beschreibung / <i>Description</i>	Stückzahl / <i>Quantity</i>
3030001	AVS-Monitor 7" FHD	1
3020030	AVS-Cable 1.10 (10 Meter)	1
3010010	AVS-Camera 105° FHD	1

## Rückfahrssystem 7" Monitor IP66 FHD / *Rear View System 7" Monitor IP66 FHD*

AVS-Monitor 7" Quad FHD waterproof



Artikelnummer/ <i>Item number</i>	Beschreibung / <i>Description</i>	Stückzahl / <i>Quantity</i>
3030004	AVS-Monitor 7" Quad FHD w	1
3020030	AVS-Cable 1.10 (10 Meter)	1
3010090	AVS-Camera-KU 115° FHD	1

## Gabelträger-System (Mastkabel) / Fork Carriage mounted system (mast cable)

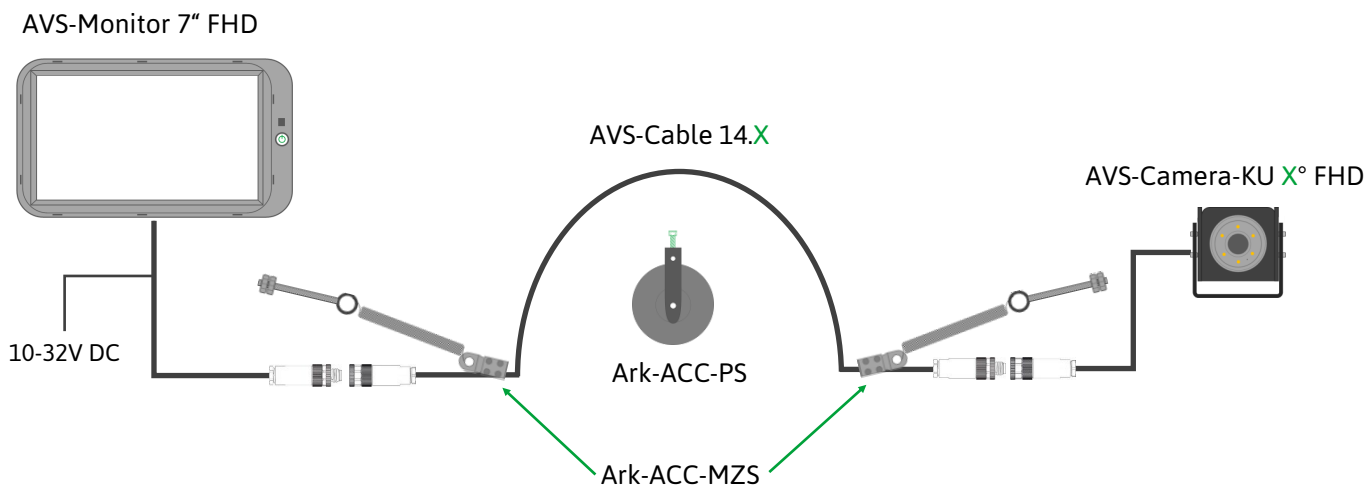

Artikelnummer/ Item number	Beschreibung / Description	Stückzahl / Quantity
3030001	AVS-Monitor 7" FHD	1
3020088	AVS-Cable 14.8 (8 Meter)	1
3040028	Ark-ACC-PS	1
3040027	Ark-ACC-MSZ	1
3010126	AVS-Camera-KU 90° FHD	1

## Gabelträger-System (Spiralkabel) / Fork Carriage mounted system (spiral cable)

AVS-Monitor 7" Quad FHD waterproof

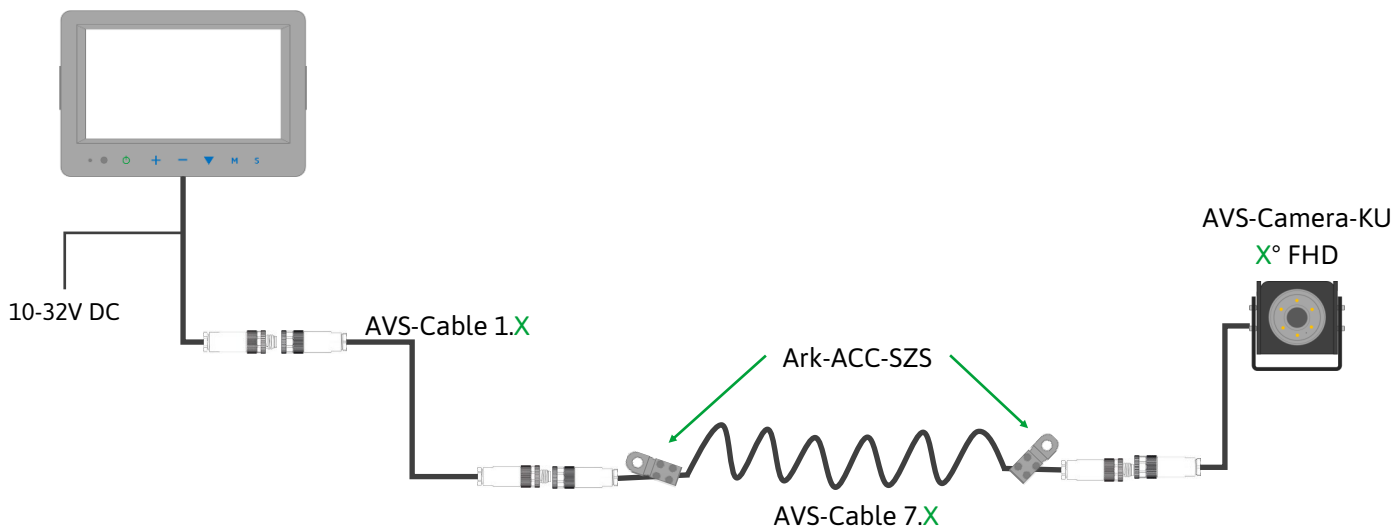

Artikelnummer/ Item number	Beschreibung / Description	Stückzahl / Quantity
3030004	AVS-Monitor 7" Quad FHD w	1
3020030	AVS-Cable 7.6 (6 Meter)	1
3040040	Ark-ACC-SZS	1
3010090	AVS-Camera-KU 115° FHD	1

## Glieder- & Sattelzug / Semi Trailer

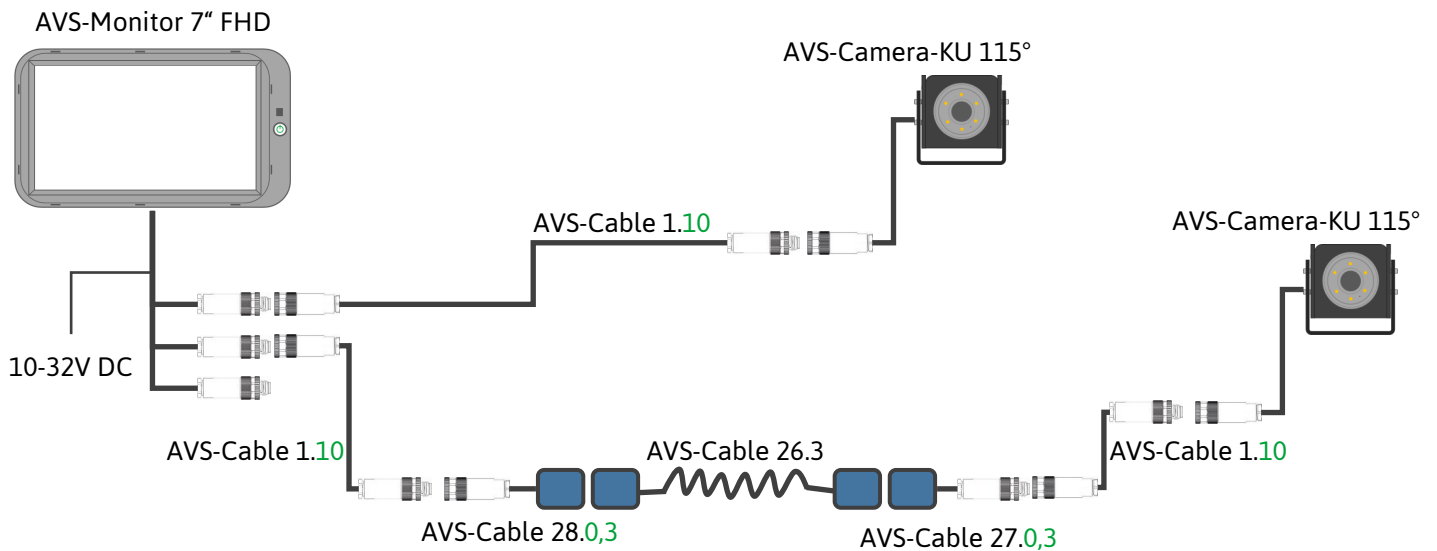

Artikelnummer/ Item number	Beschreibung / Description	Stückzahl / Quantity
3030001	AVS-Monitor 7" FHD	1
3020030	AVS-Cable 1.10 (10 Meter)	1
3020129	AVS-Cable 28.0,3	1
3020127	AVS-Cable 26.3	1
3020128	AVS-Cable 27.0,3	2
3010090	AVS-Camera-KU 115° FHD	2

## 4-Fach System 7" Monitor IP66 FHD / Quad-System 7" Monitor IP66 FHD

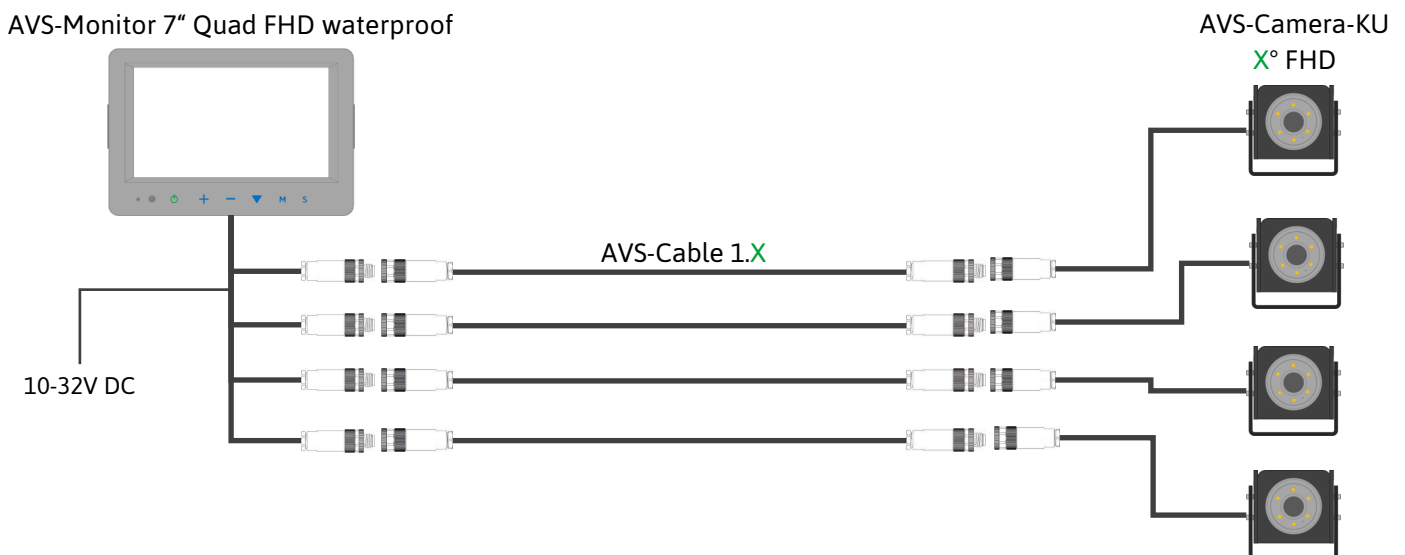

Artikelnummer/ Item number	Beschreibung / Description	Stückzahl / Quantity
3030004	AVS-Monitor 7" Quad FHD w	1
3020030	AVS-Cable 1.10 (10 Meter)	4
3010090	AVS-Camera-KU 115° FHD	4

## Zweifach Funk Kamerasystem / Duo Wireless Camerasystem

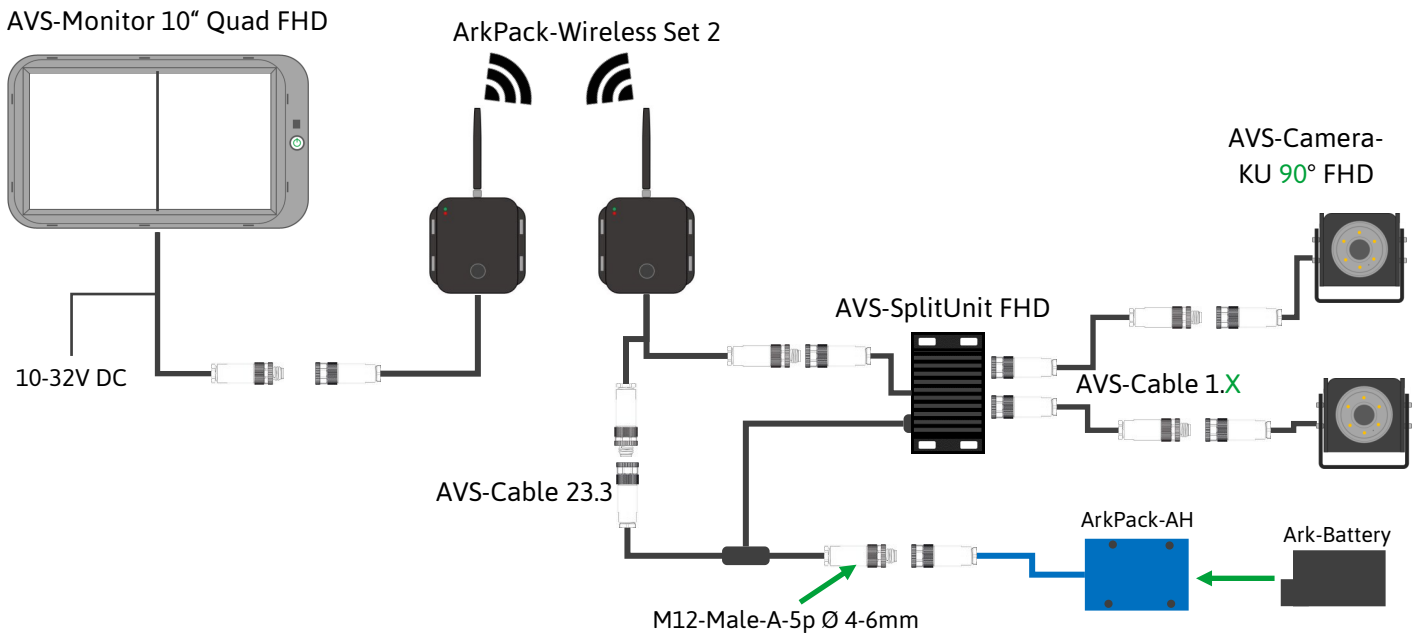

Artikelnummer/ Item number	Beschreibung / Description	Stückzahl / Quantity
3030006	AVS-Monitor 10" Quad FHD	1
3040063	ArkPack Wireless-Set-2	1
3050020	AVS-SplitUnit FHD (IP30)	1
3010126	AVS-Camera-KU 90° FHD	2

## Zweifach Kamerasystem / Duo Camerasystem

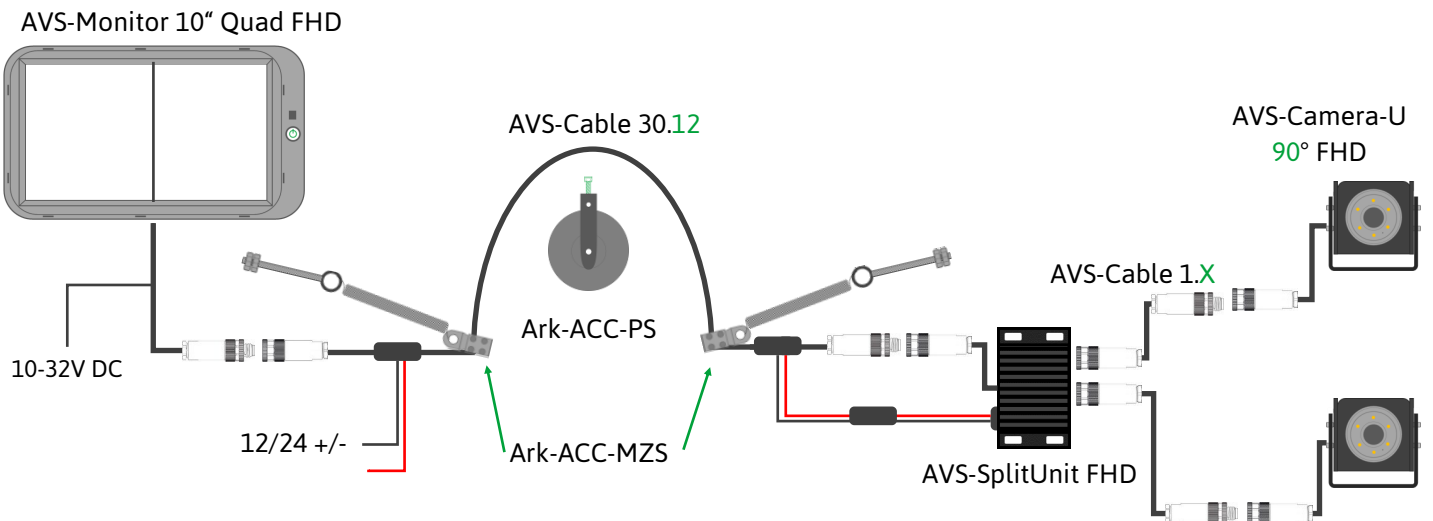

Artikelnummer/ Item number	Beschreibung / Description	Stückzahl / Quantity
3030006	AVS-Monitor 10" Quad FHD	1
3020143	AVS-Cable 30.12 (12 Meter)	1
3050020	AVS-SplitUnit FHD (IP30)	1
3040028	Ark-ACC-PS	1
3010126	AVS-Camera-KU 90° FHD	2

## Splitkabel + Funk / *Split cable + Wireless*

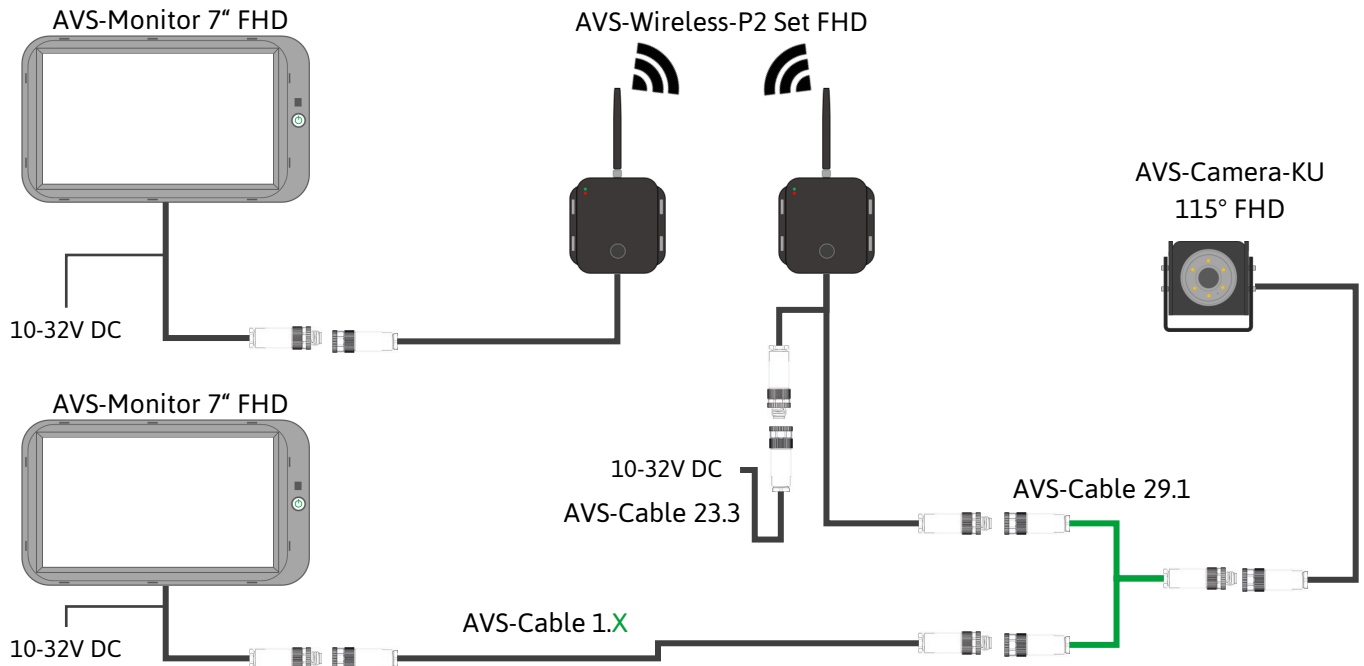

Artikelnummer/ <i>Item number</i>	Beschreibung / <i>Description</i>	Stückzahl / <i>Quantity</i>
3030001	AVS-Monitor 7" FHD	2
3310048	AVS-Wireless-Set-P2 FHD	1
3020130	AVS-Cable 29.1 (1 Meter)	1
3010090	AVS-Camera-KU 115° FHD	1

## Splitkabel / *Split cable*

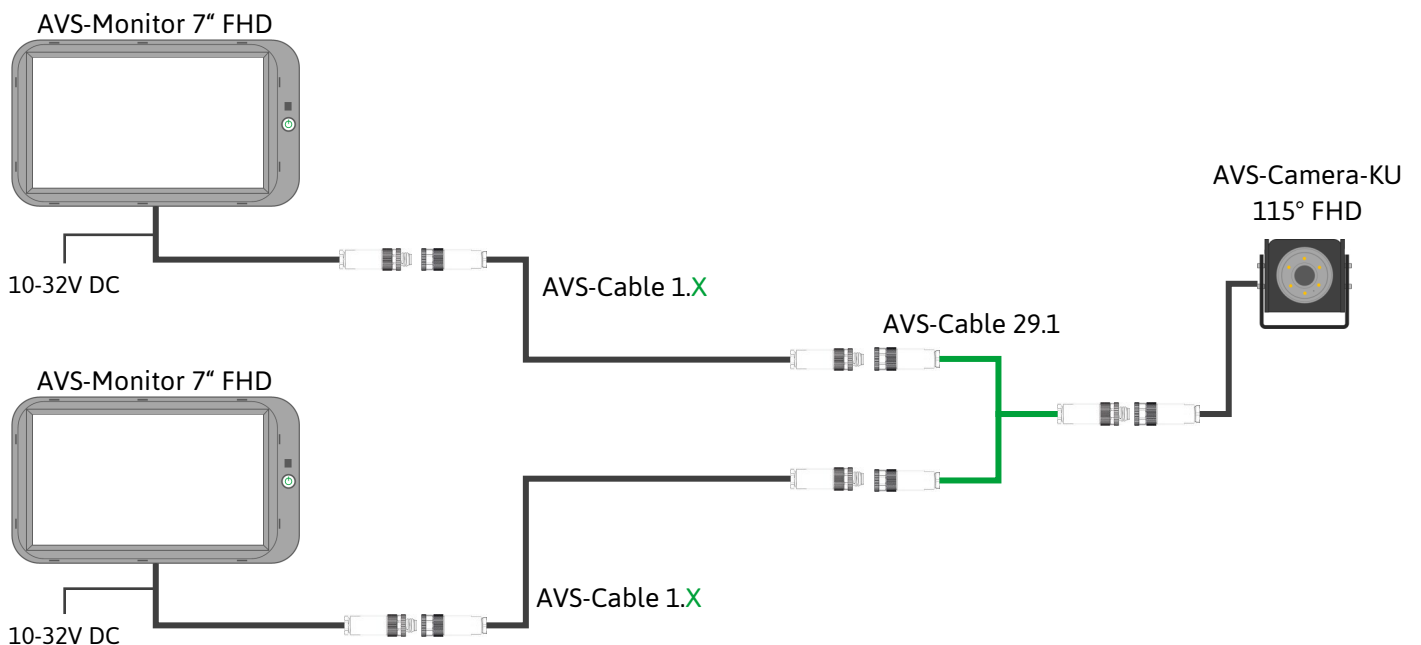

Artikelnummer/ <i>Item number</i>	Beschreibung / <i>Description</i>	Stückzahl / <i>Quantity</i>
3030001	AVS-Monitor 7" FHD	2
3020130	AVS-Cable 29.1 (1 Meter)	1
3010090	AVS-Camera-KU 115° FHD	1

## Zweifach Kamerasystem / Duo Camerasystem

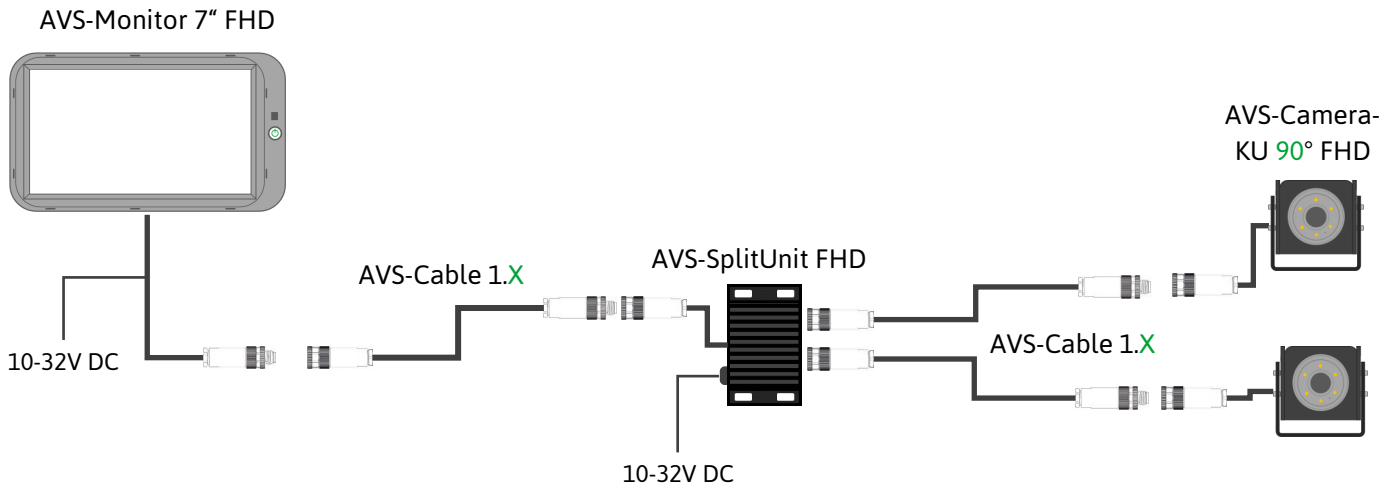

Artikelnummer/ Item number	Beschreibung / Description	Stückzahl / Quantity
3030001	AVS-Monitor 7" FHD	1
3050020	AVS-SplitUnit FHD	1
3010126	AVS-Camera-KU 90° FHD	2

## Vierfach Kamerasystem / Quad Camerasystem

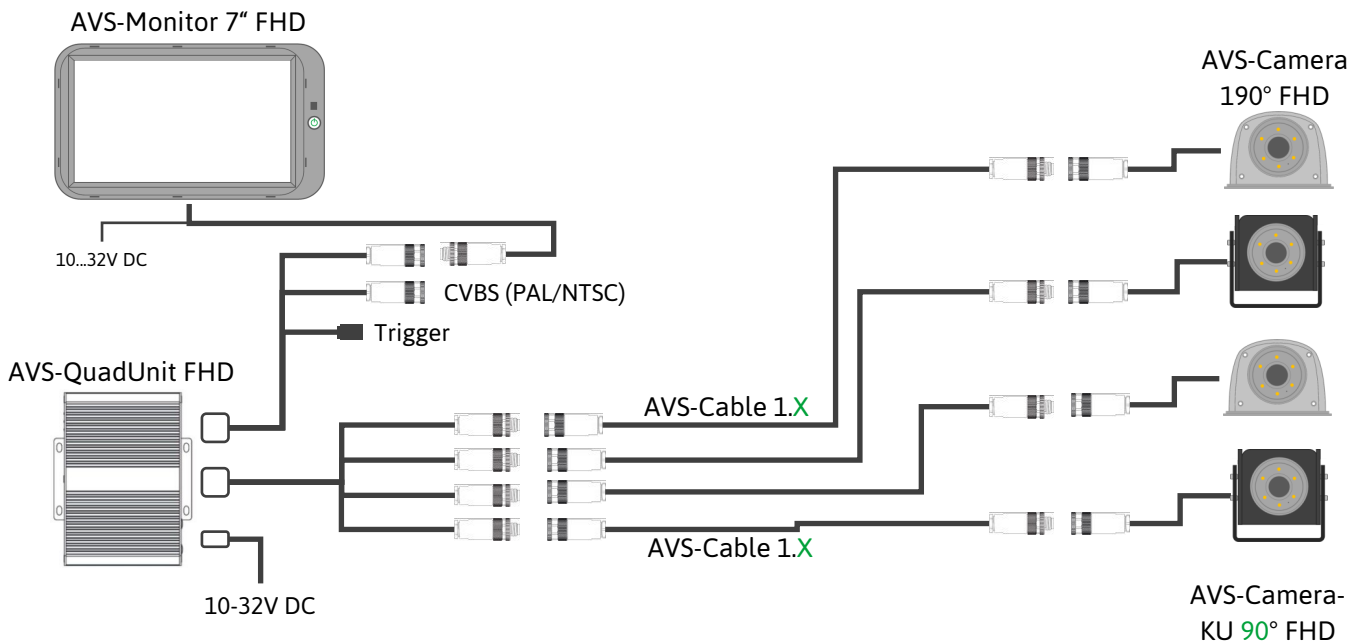

Artikelnummer/ Item number	Beschreibung / Description	Stückzahl / Quantity
3030001	AVS-Monitor 7" FHD	1
3050007	AVS-QuadUnit FHD	1
3010126	AVS-Camera-KU 90° FHD	2
3010009	AVS-Camera 145° FHD	2



## Vierfach Funk Kamerasystem / Quad Wireless Camerasystem

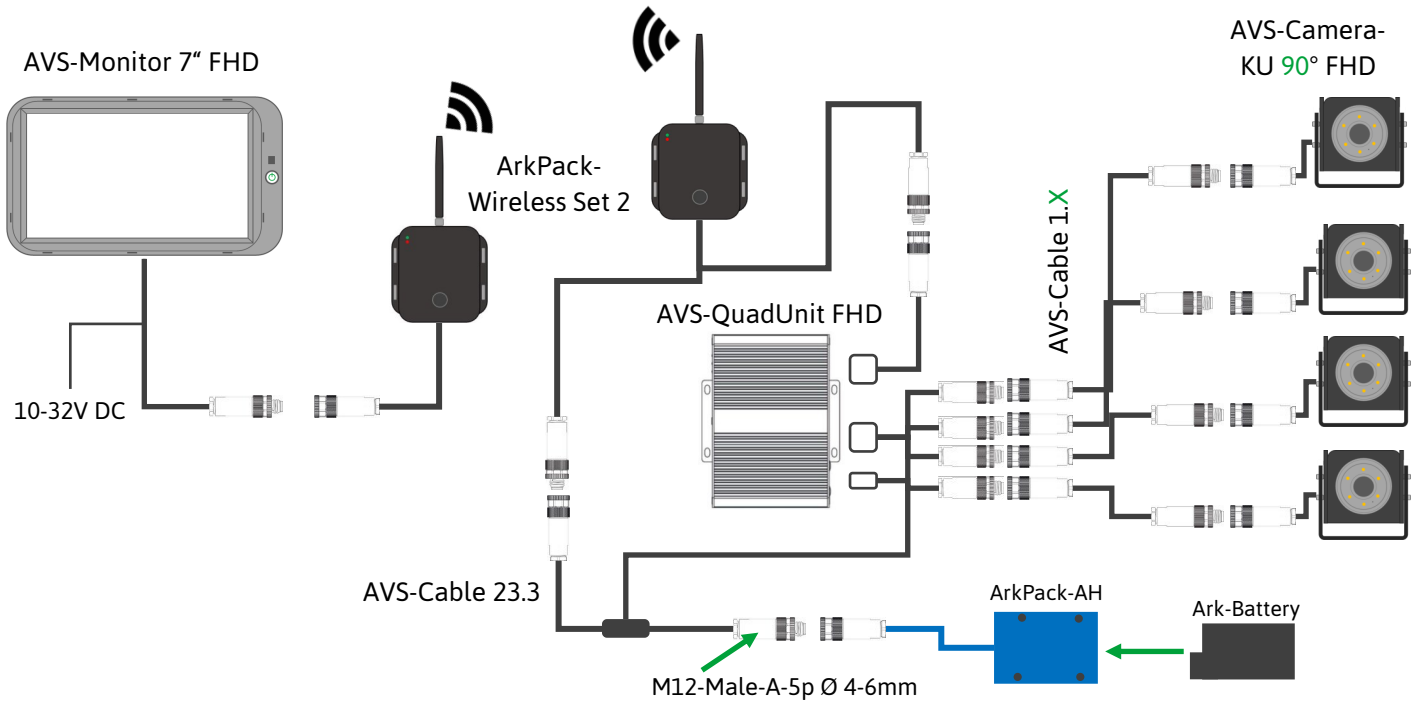

Artikelnummer/ Item number	Beschreibung / Description	Stückzahl / Quantity
3030001	AVS-Monitor 7" FHD	1
3040063	ArkPack Wireless-Set-2	1
3050007	AVS-QuadUnit FHD (IP30)	1
3010126	AVS-Camera-KU 90° FHD	2

## Vierfach Kamerasystem / Quad Camerasystem

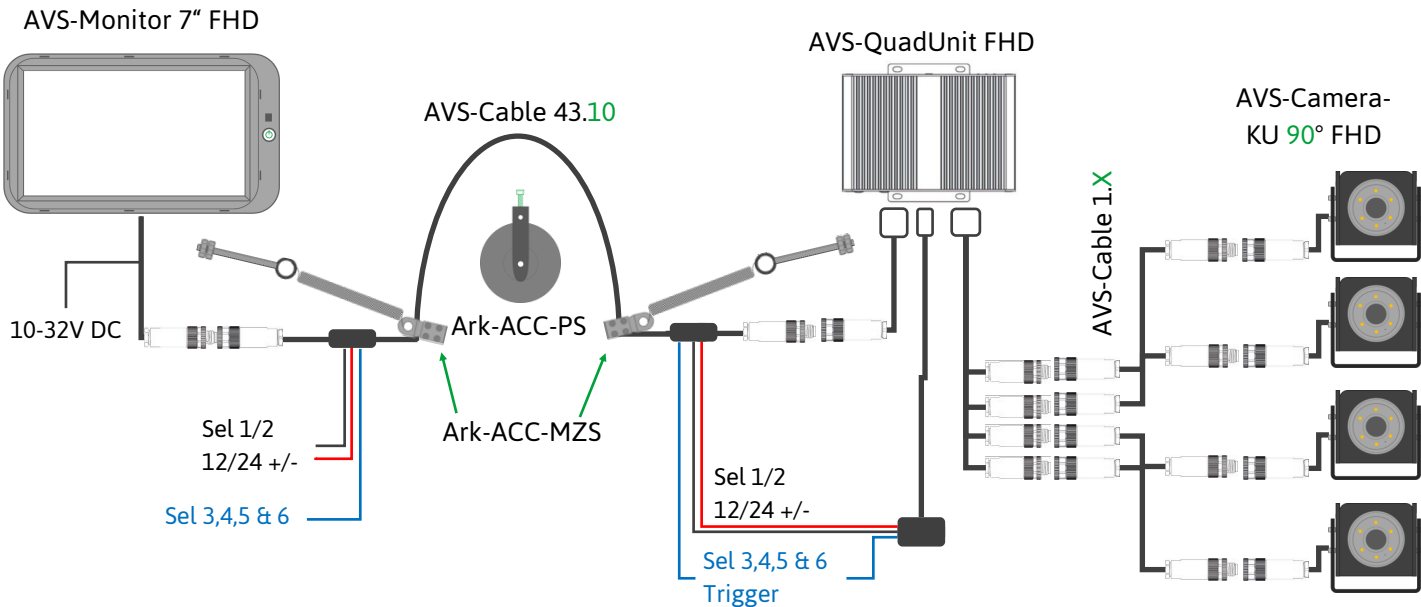

Artikelnummer/ Item number	Beschreibung / Description	Stückzahl / Quantity
3030001	AVS-Monitor 7" FHD	1
3020178	AVS-Cable 43.10 (10 Meter)	1
3050007	AVS-QuadUnit FHD (IP30)	1
3040028	Ark-ACC-PS	1
3010126	AVS-Camera-KU 90° FHD	2

# DVR - Videorekorder / Video recorder

AVS-Monitor 10" DVR FHD

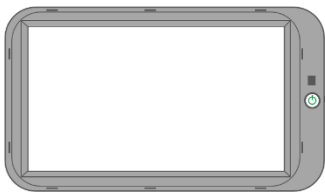

Bedienung des Videorekorder  
via Touch Monitor

Operation of the video recorder  
via Touch Monitor

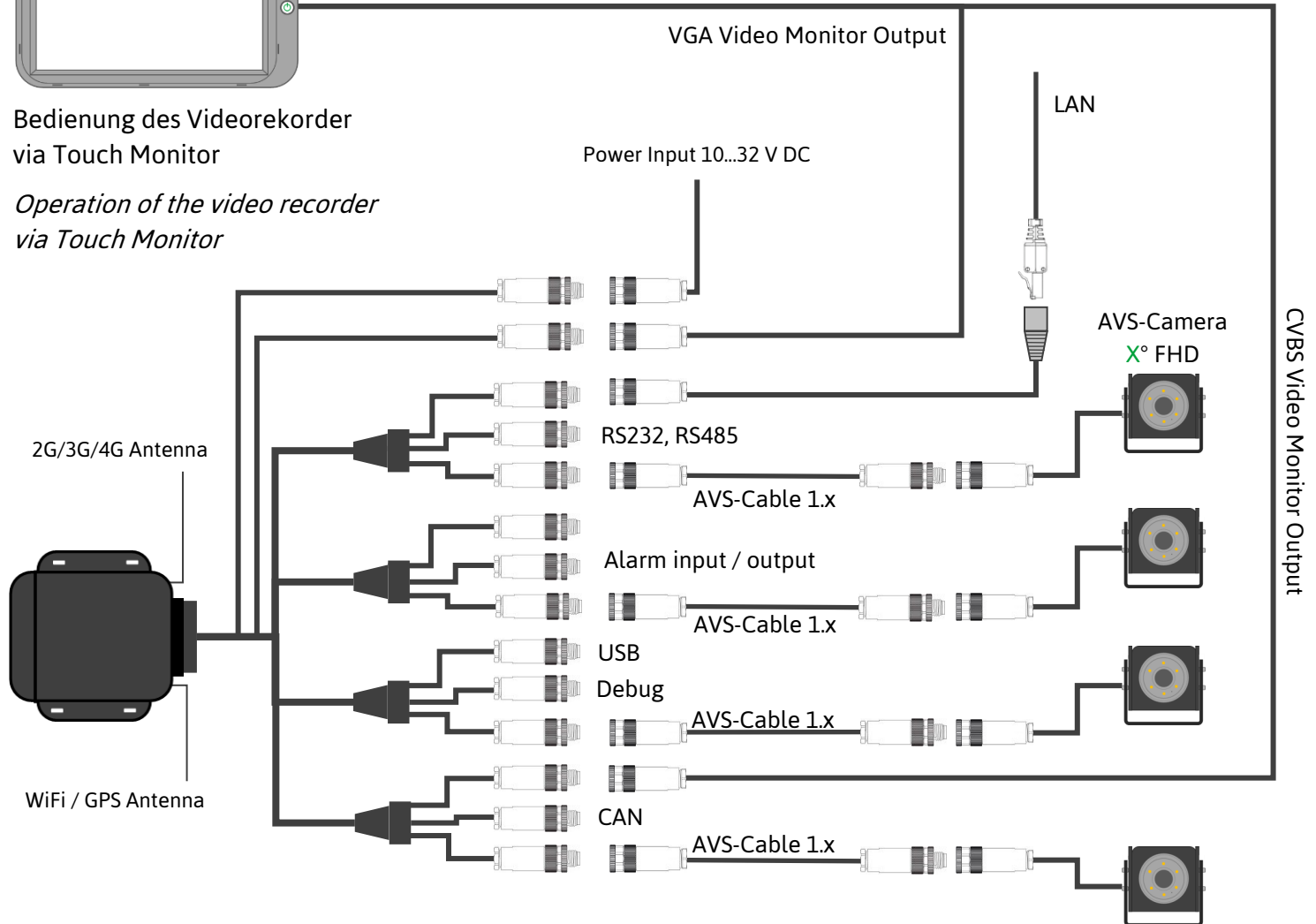

Artikelnummer/  
Item number

Beschreibung /  
Description

Stückzahl / Quantity

3030005	AVS-Monitor 10" DVR FHD	1
3020030	AVS-Cable 1.10 (10 Meter)	4
3050008	AVS-DVR1 4CH FHD	1
3010090	AVS-Camera-KU 115° FHD	4

## Funksystem HD / Wireless System FHD

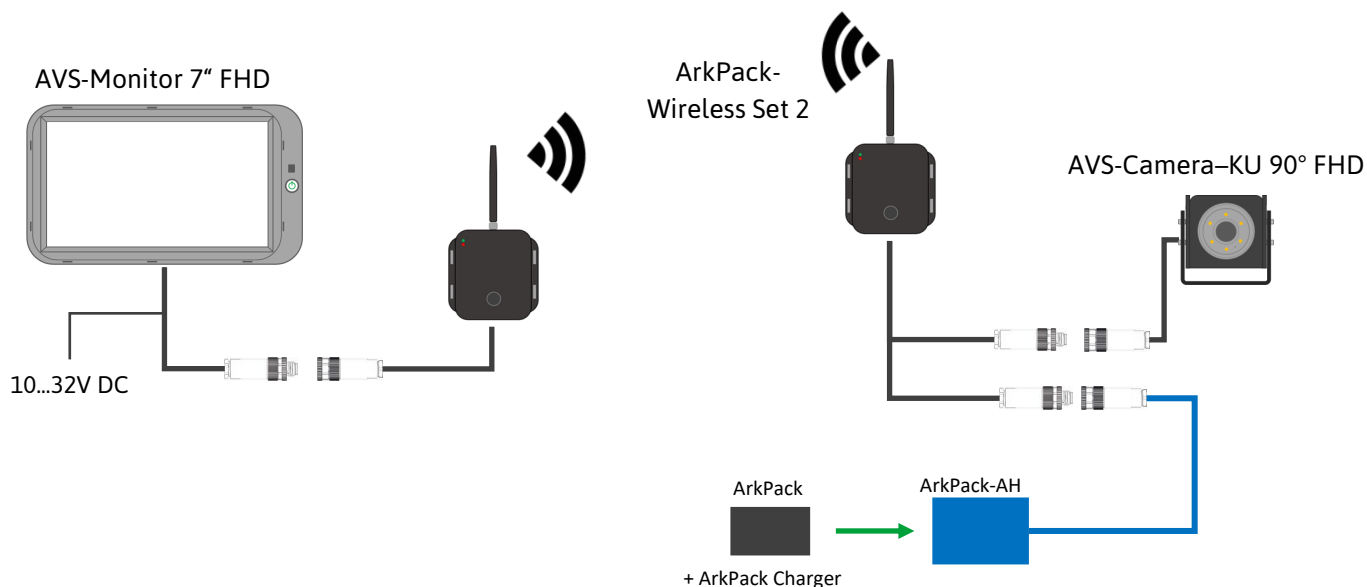

Artikelnummer/ Item number	Beschreibung / Description	Stückzahl / Quantity
3030001	AVS-Monitor 7" FHD	1
3040063	ArkPack Wireless-Set-2	1
3010126	AVS-Camera-KU 90° FHD	1

## Funksystem HD / Wireless System FHD

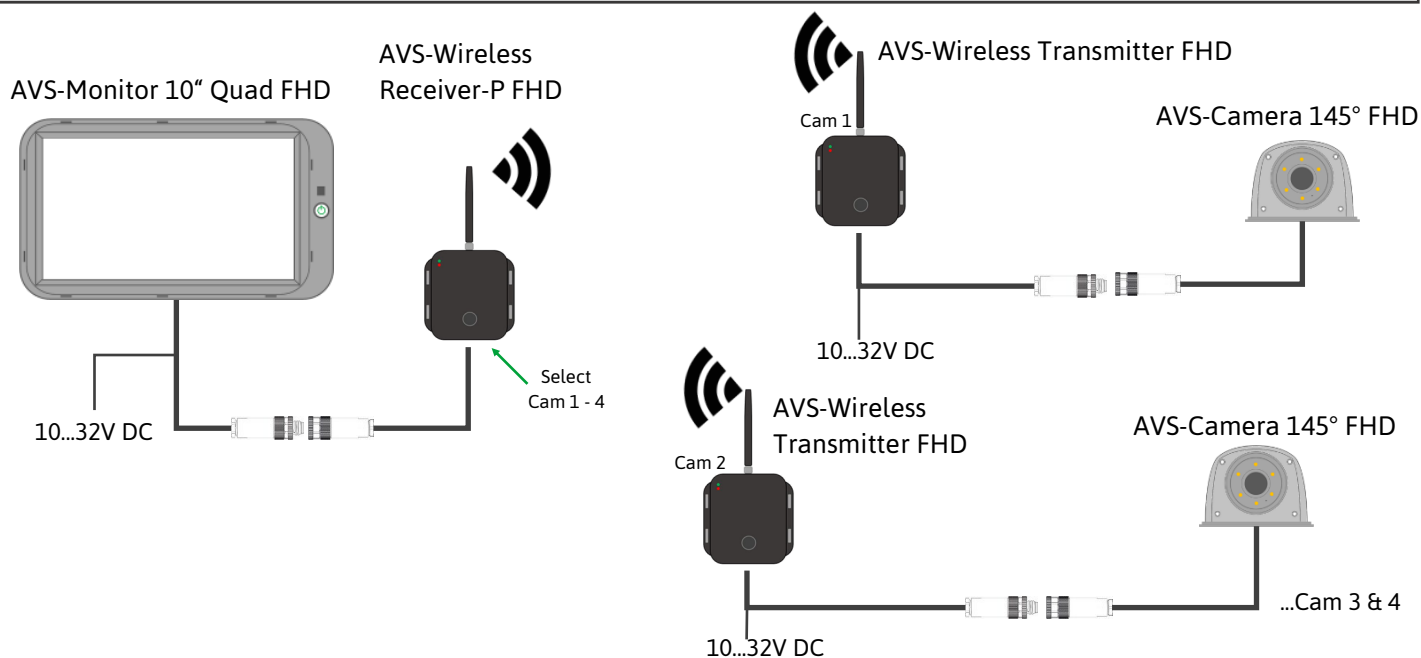

Artikelnummer/ Item number	Beschreibung / Description	Stückzahl / Quantity
3030006	AVS-Monitor 10" Quad FHD	1
3050032	AVS-Wireless Receiver-P FHD	1
3050031	AVS-Wireless Transmitter FHD	2
3010009	AVS-Camera 145° FHD	2

# Rundumsichtsystem 360° FHD / *Birdview 360° FHD*

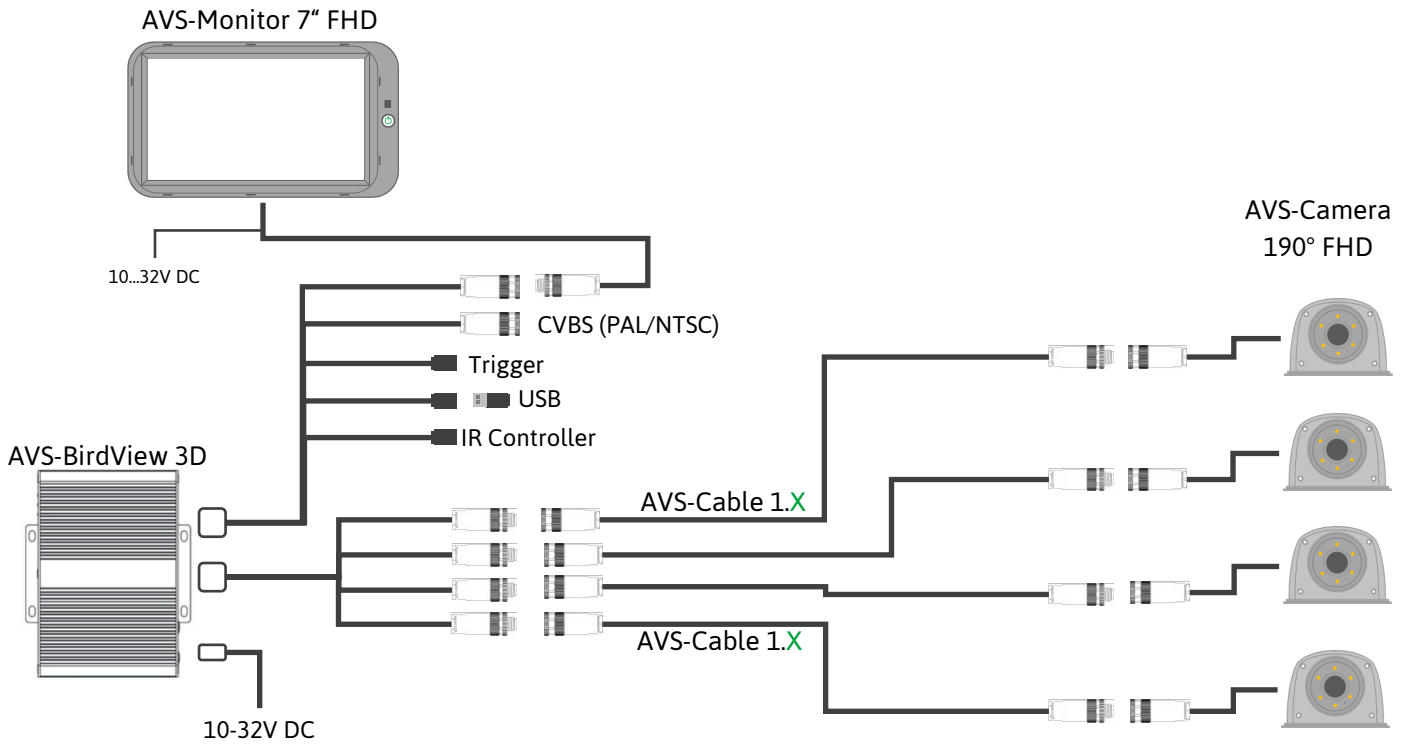

Artikelnummer/ <i>Item number</i>	Beschreibung / <i>Description</i>	Stückzahl / <i>Quantity</i>
3030001	AVS-Monitor 7" FHD	1
3020030	AVS-Cable 1.10 (10 Meter)	4
3050003	AVS-BirdView 3D	1
3010005	AVS-Camera 190° FHD	4

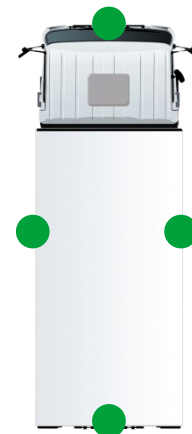
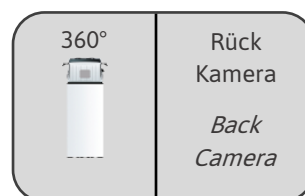
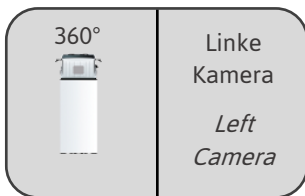
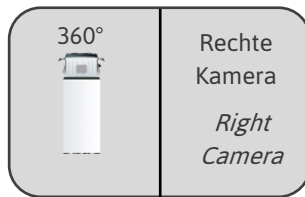

# Rundumsichtsystem 270° FHD / Birdview 270° FHD

AVS-Monitor 7" Quad FHD waterproof

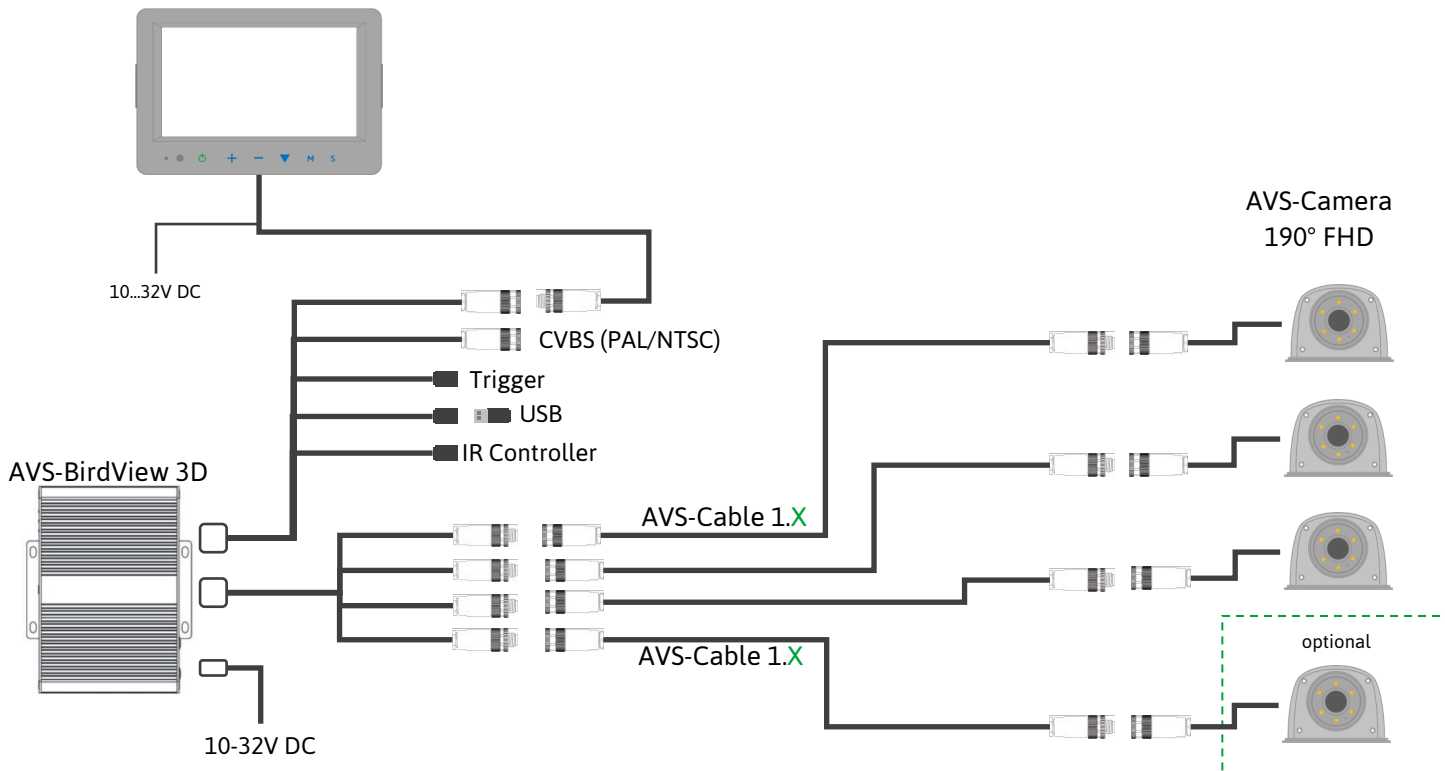

Artikelnummer/ Item number	Beschreibung / Description	Stückzahl / Quantity
3030004	AVS-Monitor 7" Quad FHD w	1
3020030	AVS-Cable 1.10 (10 Meter)	3
3050003	AVS-BirdView 3D	1
3010005	AVS-Camera 190° FHD	3

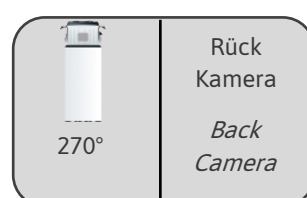
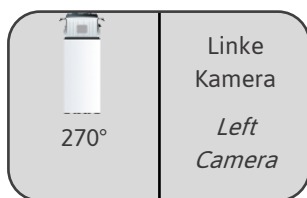
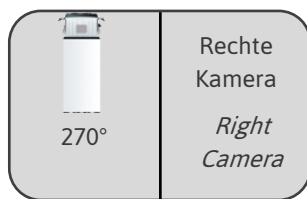
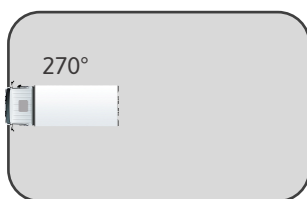

## Monitore



Monitor 7"  
Touchscreen

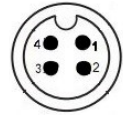

3030001	AVS-Monitor 7" FHD	<ul style="list-style-type: none"> <li>▪ Einzelbildansicht</li> <li>▪ 3x Kameraeingang</li> <li>▪ Schutzklasse IP30</li> </ul>	<ul style="list-style-type: none"> <li>▪ <i>Single View</i></li> <li>▪ <i>3x Camera input</i></li> <li>▪ <i>Protection class IP30</i></li> </ul>
---------	--------------------	--	--



Monitor 7"  
Touchscreen

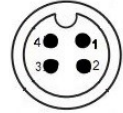

3030004	AVS-Monitor 7" Quad FHD waterproof	<ul style="list-style-type: none"> <li>▪ 4-Fach Ansicht</li> <li>▪ 4x Kameraeingang</li> <li>▪ Schutzklasse IP66</li> </ul>	<ul style="list-style-type: none"> <li>▪ <i>Quad View</i></li> <li>▪ <i>4x Camera input</i></li> <li>▪ <i>Protection class IP66</i></li> </ul>
---------	------------------------------------	---	--



Monitor 10"  
Touchscreen

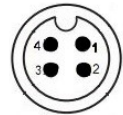

3030006	AVS-Monitor 10" Quad FHD	<ul style="list-style-type: none"> <li>▪ 4-Fach Ansicht</li> <li>▪ 4x Kameraeingang</li> <li>▪ Schutzklasse IP30</li> </ul>	<ul style="list-style-type: none"> <li>▪ <i>Quad View</i></li> <li>▪ <i>4x Camera input</i></li> <li>▪ <i>Protection class IP30</i></li> </ul>
---------	--------------------------	---	--



RAM Halterung + Montageplatte  
*RAM Mount + Mounting plate*  
„B“-Kugel / „B“ Size Ball (1 Zoll)

3310011	AVS-ACC-RAM Set 1	<ul style="list-style-type: none"> <li>▪ Gelenklänge 9,4cm</li> </ul>	<ul style="list-style-type: none"> <li>▪ <i>Joint length 9,4cm</i></li> </ul>
3310010	AVS-ACC-RAM Set 2	<ul style="list-style-type: none"> <li>▪ Gelenklänge 15,3cm</li> </ul>	<ul style="list-style-type: none"> <li>▪ <i>Joint length 15,3cm</i></li> </ul>
3310028	AVS-ACC-RAM Set 3	<ul style="list-style-type: none"> <li>▪ Gelenklänge 6,15cm</li> </ul>	<ul style="list-style-type: none"> <li>▪ <i>Joint length 6,15cm</i></li> </ul>

## Kamera / Camera



Auflösung 1920x1080 / *Resolution 1920x1080*  
 Beleuchtung IR / *Lightning IR*  
 Schutzklasse IP69K / *Protection class IP69K*

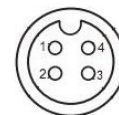

3010069	AVS-Camera-U 25° FHD	▪ Bildwinkel 25°	▪ <i>Viewing angle 25°</i>
3010068	AVS-Camera-U 40° FHD	▪ Bildwinkel 40°	▪ <i>Viewing angle 40°</i>
3010081	AVS-Camera-U 70° FHD	▪ Bildwinkel 70°	▪ <i>Viewing angle 70°</i>
3010070	AVS-Camera-U 90° FHD	▪ Bildwinkel 90°	▪ <i>Viewing angle 90°</i>
3010074	AVS-Camera-U 110° FHD	▪ Bildwinkel 110°	▪ <i>Viewing angle 110°</i>



Auflösung 1920x1080 / *Resolution 1920x1080*  
 Beleuchtung IR / *Lightning IR*  
 Schutzklasse IP69K / *Protection class IP69K*

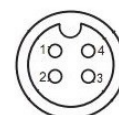

3010010	AVS-Camera 105° FHD	▪ Bildwinkel 105°	▪ <i>Viewing angle 105°</i>
3010009	AVS-Camera 145° FHD	▪ Bildwinkel 145°	▪ <i>Viewing angle 145°</i>
3010169	AVS-Camera 190° FHD IR	▪ Bildwinkel 190°	▪ <i>Viewing angle 190°</i>



Auflösung 1920x1080 / *Resolution 1920x1080*  
 Beleuchtung IR / *Lightning IR*  
 Schutzklasse IP69K / *Protection class IP69K*

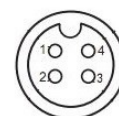

3010133	AVS-Camera-K 40° FHD	▪ Bildwinkel 40°	▪ <i>Viewing angle 40°</i>
3010124	AVS-Camera-K 90° FHD	▪ Bildwinkel 90°	▪ <i>Viewing angle 90°</i>
3010089	AVS-Camera-K 115° FHD	▪ Bildwinkel 115°	▪ <i>Viewing angle 115°</i>



Auflösung 1920x1080 / *Resolution 1920x1080*  
 Beleuchtung IR / *Lightning IR*  
 Schutzklasse IP69K / *Protection class IP69K*

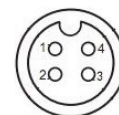

3010147	AVS-Camera-KU 40 FHD	▪ Bildwinkel 40°	▪ <i>Viewing angle 40°</i>
3010149	AVS-Camera-KU 70 FHD	▪ Bildwinkel 70°	▪ <i>Viewing angle 70°</i>
3010126	AVS-Camera-KU 90° FHD	▪ Bildwinkel 90°	▪ <i>Viewing angle 90°</i>
3010090	AVS-Camera-KU 115° FHD	▪ Bildwinkel 115°	▪ <i>Viewing angle 115°</i>

## Steuereinheit / Control Unit



Splitbox

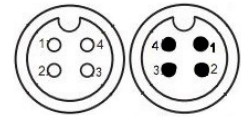

3050020	AVS-Splitbox FHD	<ul style="list-style-type: none"><li>▪ Splitansicht</li><li>▪ 2x Kameraeingang</li><li>▪ Schutzklasse IP30</li></ul>	<ul style="list-style-type: none"><li>▪ <i>Split View</i></li><li>▪ <i>2x Camera input</i></li><li>▪ <i>Protection class IP30</i></li></ul>
---------	------------------	---	---



Quadbox

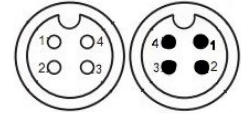

3050007	AVS-QuadUnit FHD	<ul style="list-style-type: none"><li>▪ Quad-Ansicht</li><li>▪ 4x Kameraeingang</li><li>▪ Schutzklasse IP30</li></ul>	<ul style="list-style-type: none"><li>▪ <i>Quad View</i></li><li>▪ <i>4x Camera input</i></li><li>▪ <i>Protection class IP30</i></li></ul>
---------	------------------	---	--



## Personenerkennung / *Pedestrian Detection*



Pedestrian Set

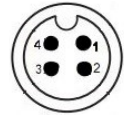

3310035	AVS-KMS Pedestrian	<ul style="list-style-type: none"> <li>1x Monitor (3030001)</li> <li>1x Kabel 10 Meter (3020030)</li> <li>1x AI-Kamera (3010114)</li> </ul>	<ul style="list-style-type: none"> <li>1x Monitor (3030001)</li> <li>1x Cable 10 Meter (3020030)</li> <li>1x AI-Camera (3010114)</li> </ul>
---------	--------------------	---	---



Kamera für Personenerkennung  
*Camera for Pedestrian Detection*



3010114	AVS-Camera-U 140° AI	<ul style="list-style-type: none"> <li>Bildwinkel 140°</li> <li>Schutzklasse IP69K</li> <li>IR</li> </ul>	<ul style="list-style-type: none"> <li>Viewing angle 110°</li> <li>Protection class IP30</li> <li>IR</li> </ul>
---------	----------------------	---	---



Wlan Antenne / *Wifi Antenna*  
Kalibrierung via Smartphone oder PC /  
*Calibration via Smartphone oder PC*

3040056	AVS-Calibration-Kit AI	<ul style="list-style-type: none"> <li>Wlan Antenne für Kamera Kalibrierung</li> </ul>	<ul style="list-style-type: none"> <li>Wifi Antenne for Camera Calibration</li> </ul>
---------	------------------------	--	---



Verlängerungskabel AVS-Camera-U X AI  
*Extension cable AVS-Camera-U X AI*

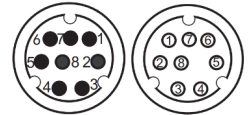

3020147	AVS-Cable 31.5	<ul style="list-style-type: none"> <li>Länge 5 Meter</li> </ul>	<ul style="list-style-type: none"> <li>Length 5 Meter</li> </ul>
3020148	AVS-Cable 31.10	<ul style="list-style-type: none"> <li>Länge 10 Meter</li> </ul>	<ul style="list-style-type: none"> <li>Length 10 Meter</li> </ul>



## Kameras / Cameras (PAL System)



Auflösung 976x596 / *Resolution 976x596*  
 Beleuchtung IR / *Lightning IR*  
 MiniDINW Stecker 4polig / *MiniDINW Male 4pole*

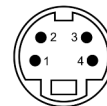

3010085	AVS-Camera-U 90° PAL	▪ Bildwinkel 90°	▪ <i>Viewing angle 90°</i>
---------	----------------------	------------------	----------------------------



Auflösung 976x596 / *Resolution 976x596*  
 Beleuchtung IR / *Lightning IR*  
 M12A-kodiert Stecker 5polig / *M12A-coded Male 5pole*

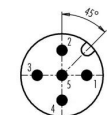

3010135	AVS-Camera-UM 90° PAL	▪ Bildwinkel 90°	▪ <i>Viewing angle 90°</i>
---------	-----------------------	------------------	----------------------------



Auflösung 976x596 / *Resolution 976x596*  
 Beleuchtung IR / *Lightning IR*  
 M12A-kodiert Buchse 5polig / *M12A-coded Female 5pole*

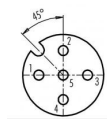

3010143	AVS-Camera-UF 90° PAL	▪ Bildwinkel 90°	▪ <i>Viewing angle 90°</i>
---------	-----------------------	------------------	----------------------------



Adapter M12A-kodiert Stecker 5polig auf MiniDINW Buchse 4polig  
*Adapter M12A-kodiert Male 5polig to MiniDINW Female 4polig*

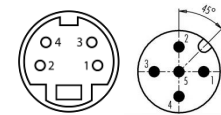

3020119	AVS-Cable 22.0,2	▪ Länge 0,2 Meter	▪ <i>Length 0,2 Meter</i>
---------	------------------	-------------------	---------------------------

## Funksystem FHD / *Wireless System FHD*



Funk Sender & *Wireless Transmitter (PAL/720p/1080p)*  
 Funk Empfänger & *Wireless Receiver (PAL/720p/1080p)*  
 Schutzklasse IP69K / *Protection class IP69K*

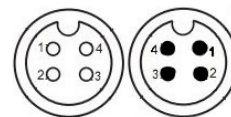

3050032	AVS-Wireless Receiver-P FHD	<ul style="list-style-type: none"> <li>Empfänger Stromversorgung über Monitor</li> </ul>	<ul style="list-style-type: none"> <li><i>Receiver Power over Monitor</i></li> </ul>
3050031	AVS-Wireless Transmitter FHD	<ul style="list-style-type: none"> <li>Sender externe Stromversorgung</li> </ul>	<ul style="list-style-type: none"> <li><i>Transmitter external Power</i></li> </ul>
3310048	AVS-Wireless-Set-P FHD	<ul style="list-style-type: none"> <li>Sender &amp; Empfänger Set 3050031, 3050032 &amp; 3020120</li> </ul>	<ul style="list-style-type: none"> <li><i>Receiver &amp; Transmitter Set 3050031, 3050032 &amp; 3020120</i></li> </ul>



Stromkabel Wireless Transmitter (Länge 3 Meter)  
*Powercable Wireless Transmitter (Length 3 Meter)*

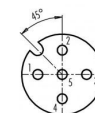

3020120	AVS-Cable 23.5	<ul style="list-style-type: none"> <li>M12A-kodiert Buchse 5polig</li> </ul>	<ul style="list-style-type: none"> <li>M12A-coded Female 5pole</li> </ul>
---------	----------------	--	---



Akku System  
 Battery System

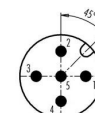

3040050	ArkPack	<ul style="list-style-type: none"> <li>Gehäuse + Akku</li> </ul>	<ul style="list-style-type: none"> <li><i>Housing + Battery</i></li> </ul>
3040052	ArkPack-Battery	<ul style="list-style-type: none"> <li>Akku</li> </ul>	<ul style="list-style-type: none"> <li><i>Battery</i></li> </ul>
3040051	ArkPack-AH	<ul style="list-style-type: none"> <li>Gehäuse</li> </ul>	<ul style="list-style-type: none"> <li><i>Housing</i></li> </ul>
3040053	ArkPack-Charger	<ul style="list-style-type: none"> <li>Ladegerät</li> </ul>	<ul style="list-style-type: none"> <li><i>Charger</i></li> </ul>



Lieferumfang / *Scope of delivery.*  
 ArkPack (3040050), ArkPack Battery (3040052), ArkPack Charger (3040053),  
 AVS-Wireless Receiver-P FHD (3050032) & AVS-Wireless Transmitter FHD (3050031)

3040063	ArkPack Wireless-Set-2	<ul style="list-style-type: none"> <li>Akku System + Funk</li> </ul>	<ul style="list-style-type: none"> <li><i>Battery System + Wireless</i></li> </ul>
---------	------------------------	--	--

## Rundumsicht / *Bird View*



Spannungsversorgung 10-32V DC / *Power Supply 10-32V DC*  
 Speicher 2x SD Karte Slot / *Storage 2x SD Card Slot*  
 Schutzklasse IP30 / *Protection class IP30*

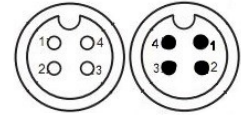

3050003	AVS-BirdView 3D	<ul style="list-style-type: none"> <li>▪ Rundumsicht Steuereinheit 3D/2D</li> <li>▪ 270° oder 360°</li> </ul>	<ul style="list-style-type: none"> <li>▪ <i>Birdview ControlUnit 3D/2D</i></li> <li>▪ <i>270° or 360°</i></li> </ul>
---------	-----------------	---	--



Auflösung 1920x1080 / *Resolution 1920x1080*  
 Schutzklasse IP69K / *Protection class IP69K*

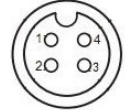

3010005	AVS-Camera 190° FHD	<ul style="list-style-type: none"> <li>▪ Bildwinkel 190°</li> </ul>	<ul style="list-style-type: none"> <li>▪ <i>Viewing angle 190°</i></li> </ul>
---------	---------------------	---	---

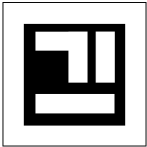

3040031	AVS-Calibration-Kit 2	<ul style="list-style-type: none"> <li>▪ Kalibrierplatten für 3D System</li> </ul>	<ul style="list-style-type: none"> <li>▪ <i>Calibration Mats for 3D System</i></li> </ul>
---------	-----------------------	--	---

## DVR (Videorekorder / Videorecorder)



Monitor 10" für DVR  
*Monitor 10" for DVR*

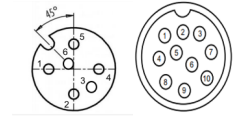

3030005	AVS-Monitor 10" DVR FHD	<ul style="list-style-type: none"> <li>▪ Nur für DVR</li> <li>▪ Bedienung DVR via Touch</li> <li>▪ Schutzklasse IP30</li> </ul>	<ul style="list-style-type: none"> <li>▪ <i>Only for DVR</i></li> <li>▪ <i>Control DVR via Touch</i></li> <li>▪ <i>Protection class IP30</i></li> </ul>
---------	-------------------------	---	---



Videorekorder 4 Kanal  
*Videorecorder 4 Channel*

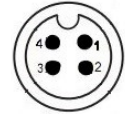

3050016	AVS-DVR4 4CH FHD	<ul style="list-style-type: none"> <li>▪ 1x SSD Slot, 1x SD Karten Slot</li> <li>▪ 4x Kameraeingang</li> <li>▪ Schutzklasse IP69K</li> </ul>	<ul style="list-style-type: none"> <li>▪ <i>1x SSD Slot, 1x SD Card Slot</i></li> <li>▪ <i>4x Camera input</i></li> <li>▪ <i>Protection class IP69K</i></li> </ul>
---------	------------------	--	--

## Kabel / Cable

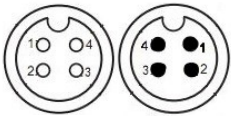

Verbindungskabel M12A/4p  
*Connection cable M12A/4p*

3020085	AVS-Cable 1.1	▪ Länge 1 Meter	▪ <i>Length 1 Meter</i>
3020121	AVS-Cable 1.2	▪ Länge 2 Meter	▪ <i>Length 2 Meter</i>
3020028	AVS-Cable 1.3	▪ Länge 3 Meter	▪ <i>Length 3 Meter</i>
3020029	AVS-Cable 1.5	▪ Länge 5 Meter	▪ <i>Length 5 Meter</i>
3020122	AVS-Cable 1.7	▪ Länge 7 Meter	▪ <i>Length 7 Meter</i>
3020030	AVS-Cable 1.10	▪ Länge 10 Meter	▪ <i>Length 10 Meter</i>
3020031	AVS-Cable 1.15	▪ Länge 15 Meter	▪ <i>Length 15 Meter</i>
3020035	AVS-Cable 1.20	▪ Länge 20 Meter	▪ <i>Length 20 Meter</i>
<b>*weitere Längen auf Anfrage / other length on demand</b>			

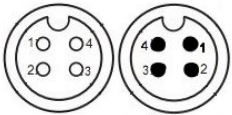

Spiral Verbindungskabel M12A/4p  
*Spiral Connection cable M12A/4p*



3020072	AVS-Cable 7.3	▪ Länge 3 Meter	▪ <i>Length 3 Meter</i>
3020073	AVS-Cable 7.6	▪ Länge 6 Meter	▪ <i>Length 6 Meter</i>

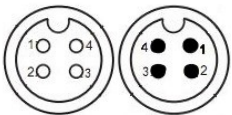

Mastkabel für Gabelstapler M12A/4p  
*Mast cable for Forklift M12A/4p*

3020170	AVS-Cable 14.5	▪ Länge 5 Meter	▪ <i>Length 5 Meter</i>
3020087	AVS-Cable 14.6	▪ Länge 6 Meter	▪ <i>Length 6 Meter</i>
3020088	AVS-Cable 14.8	▪ Länge 8 Meter	▪ <i>Length 8 Meter</i>
3020135	AVS-Cable 14.9	▪ Länge 9 Meter	▪ <i>Length 9 Meter</i>
3020092	AVS-Cable 14.10	▪ Länge 10 Meter	▪ <i>Length 10 Meter</i>
3020089	AVS-Cable 14.12	▪ Länge 12 Meter	▪ <i>Length 12 Meter</i>
3020090	AVS-Cable 14.14	▪ Länge 14 Meter	▪ <i>Length 14 Meter</i>
3020114	AVS-Cable 14.15	▪ Länge 15 Meter	▪ <i>Length 15 Meter</i>
3020091	AVS-Cable 14.16	▪ Länge 16 Meter	▪ <i>Length 16 Meter</i>
<b>*weitere Längen auf Anfrage / other length on demand</b>			

## Kabel / Cable



Adapter für Motec / Brigade (Länge 0,2 Meter)  
*Adapter for Motec / Brigade (Length 0,2 Meter)*

3020036	AVS-Cable 3.0,2	▪ M12A-F-4p / MiniDINW-F-4p	Monitor
3020060	AVS-Cable 6.0,2	▪ M12A-M-4p / MiniDINW-M-4p	Kamera / Camera



Adapter für Motec (Länge 0,2 Meter)  
*Adapter for Motec (Length 0,2 Meter)*

3020051	AVS-Cable 4.0,2	▪ M12A-F-4p / M12A-F-5p	Monitor
3020052	AVS-Cable 5.0,2	▪ M12A-M-4p / M12A-M-5p	Kamera / Camera



Adapter Rundumsicht Cinch (Länge 3 Meter)  
*Adapter Bird View Cinch (Length 3 Meter)*

3020074	AVS-Cable 8.3	▪ M12A-M/4p auf Cinch	▪ M12A-M/4p to Cinch
---------	---------------	-----------------------	----------------------



Adapter Kamera Cinch + Stromversorgung (Länge 0,5 Meter)  
*Adapter Camera Cinch + Power Supply (Length 0,5 Meter)*

3020032	AVS-Cable 2.0,5	▪ M12A-M/4p auf Cinch	▪ M12A-M/4p to Cinch
---------	-----------------	-----------------------	----------------------



Adapter für Motec / Orlaco (Länge 0,2 Meter)  
*Adapter for Motec / Orlaco (Length 0,2 Meter)*

3020093	AVS-Cable 16.0,2	▪ M12A-F-4p / M16-F-4p	Monitor
3020094	AVS-Cable 17.0,2	▪ M12A-M-4p / M16-M-4p	Kamera / Camera



Adapter Motec Steuereinheit (MBxxxx, Länge 1 Meter)  
*Adapter Motec ControlUnit (MBxxxx, Length 1 Meter)*

3020086	<sup>1</sup> AVS-Cable 11.1	▪ M12A-F-4p / SUBMIND 9p	▪ Monitor - MBxxxx
---------	-----------------------------	--------------------------	--------------------



Splittkabel 1 Kameraeingang auf 2 Ausgänge (Länge 1 Meter)  
*Split cable 1 camera input to 2 outputs (Length 1 Meter)*

3020130	AVS-Cable 29.1	▪ 1x M12 M 4p auf 2x M12 F 4p	▪ 1x M12 M 4p to 2x M12 F 4p
---------	----------------	-------------------------------	------------------------------

## Kabel / Cable

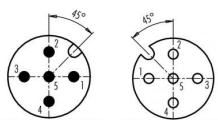

Ersatzartikel MKS M12A-F-5p auf M12A-M-5p  
Replacement article MKS M12A-F-5p to M12A-M-5p

3020101	AVS-Cable 19.1	▪ Länge 1 Meter	▪ <i>Length 1 Meter</i>
3020102	AVS-Cable 19.1,5	▪ Länge 1,5 Meter	▪ <i>Length 1,5 Meter</i>
3020103	AVS-Cable 19.2	▪ Länge 2 Meter	▪ <i>Length 2 Meter</i>
3020104	AVS-Cable 19.3	▪ Länge 3 Meter	▪ <i>Length 3 Meter</i>
3020105	AVS-Cable 19.5	▪ Länge 5 Meter	▪ <i>Length 5 Meter</i>
3020106	AVS-Cable 19.10	▪ Länge 10 Meter	▪ <i>Length 10 Meter</i>
<b>*weitere Längen auf Anfrage / other length on demand</b>			

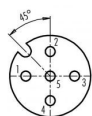

Stromkabel Wireless Transmitter (Länge 3 Meter)  
Powercable Wireless Transmitter (Length 3 Meter)

3020120	AVS-Cable 23.5	▪ M12A-kodiert Buchse 5polig	▪ <i>M12A-coded Female 5pole</i>
---------	----------------	------------------------------	----------------------------------

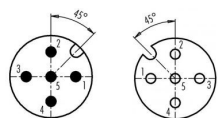

Schleppkettenkable für Abfallsammelfahrzeuge M12A/5p  
Drag chain cable for waste collection vehicles M12A/5p

3020080	AVS-Cable 13.5	▪ Länge 5 Meter	▪ <i>Length 5 Meter</i>
3020175	AVS-Cable 13.12	▪ Länge 12 Meter	▪ <i>Length 12 Meter</i>
3020133	AVS-Cable 13.22	▪ Länge 22 Meter	▪ <i>Length 22 Meter</i>
3020149	AVS-Cable 13.30	▪ Länge 30 Meter	▪ <i>Length 30 Meter</i>
3020134	AVS-Cable 13.32	▪ Länge 32 Meter	▪ <i>Length 32 Meter</i>
3020151	AVS-Cable 13.35	▪ Länge 35 Meter	▪ <i>Length 35 Meter</i>
<b>*weitere Längen auf Anfrage / other length on demand</b>			

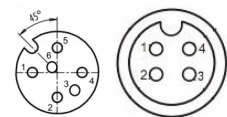

Adapter DVR Monitor (Länge 2 Meter)  
Adapter DVR Monitor (Length 2 Meter)

3020075	AVS-Cable 9.2	▪ CVBS 6p auf 4p	▪ <i>CVBS 6p to 4p</i>
---------	---------------	------------------	------------------------

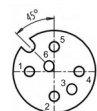

Verlängerung DVR Monitor (Länge 5 Meter)  
Extension Cable DVR Monitor (Length 5 Meter)

3020124	AVS-Cable 24.5	▪ CVBS 6p auf 6p	▪ <i>CVBS 6p to 6p</i>
---------	----------------	------------------	------------------------

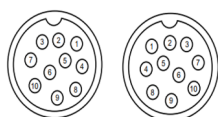

Adapter DVR Monitor (Länge 5 Meter)  
Extension Cable DVR Monitor (Length 5 Meter)

3020125	AVS-Cable 25.5	▪ CVBS 10p auf 10p	▪ <i>CVBS 10p to 10p</i>
---------	----------------	--------------------	--------------------------



## Kabel / Cable

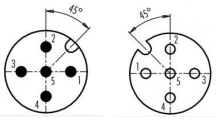

Mastkabel für Gabelstapler M12A/5p  
Mast cable for Forklift M12A/5p

3020193	AVS-Cable 15.4	▪ Länge 4 Meter	▪ <i>Length 4 Meter</i>
3020076	AVS-Cable 15.6	▪ Länge 6 Meter	▪ <i>Length 6 Meter</i>
3020077	AVS-Cable 15.8	▪ Länge 8 Meter	▪ <i>Length 8 Meter</i>
3020078	AVS-Cable 15.10	▪ Länge 10 Meter	▪ <i>Length 10 Meter</i>
3020079	AVS-Cable 15.12	▪ Länge 12 Meter	▪ <i>Length 12 Meter</i>
3020083	AVS-Cable 15.14	▪ Länge 14 Meter	▪ <i>Length 14 Meter</i>
3020109	AVS-Cable 15.15	▪ Länge 15 Meter	▪ <i>Length 15 Meter</i>
3020084	AVS-Cable 15.16	▪ Länge 16 Meter	▪ <i>Length 16 Meter</i>
3020123	AVS-Cable 15.20	▪ Länge 20 Meter	▪ <i>Length 20 Meter</i>
<b>*weitere Längen auf Anfrage / other length on demand</b>			

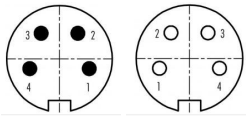

Mastkabel für Gabelstapler M16/4p  
Mast cable for Forklift M16/4p

3020116	AVS-Cable 21.6	▪ Länge 6 Meter	▪ <i>Length 6 Meter</i>
3020117	AVS-Cable 21.8	▪ Länge 8 Meter	▪ <i>Length 8 Meter</i>
3020118	AVS-Cable 21.10	▪ Länge 10 Meter	▪ <i>Length 10 Meter</i>
3020126	AVS-Cable 21.13	▪ Länge 13 Meter	▪ <i>Length 13 Meter</i>
3020131	AVS-Cable 21.15	▪ Länge 15 Meter	▪ <i>Length 15 Meter</i>
3020210	AVS-Cable 21.20	▪ Länge 20 Meter	▪ <i>Length 20 Meter</i>
<b>*weitere Längen auf Anfrage / other length on demand</b>			



Spiral Verbindungskabel Jaeger (Länge 3 Meter)  
Spiral Connection cable Jaeger (Length 3 Meter)

3020127	AVS-Cable 26.3	▪ Jaeger auf Jaeger	▪ <i>Jaeger to Jaeger</i>
---------	----------------	---------------------	---------------------------



Jaeger Buchse auf M12 Stecker 4p (Länge 0,3 Meter)  
Jaeger Female to M12 Male 4p (Length 0,3 Meter)

3020128	AVS-Cable 27.0,3	▪ Jaeger auf M12-Stecker 4p	▪ <i>Jaeger to M12-Male 4p</i>
---------	------------------	-----------------------------	--------------------------------



Jaeger Buchse auf M12 Buchse 4p (Länge 0,3 Meter)  
Jaeger Female to M12 Female 4p (Length 0,3 Meter)

3020129	AVS-Cable 28.0,3	▪ Jaeger auf M12-Buchse 4p	▪ <i>Jaeger to M12-Female 4p</i>
---------	------------------	----------------------------	----------------------------------

## Kabel / Cable

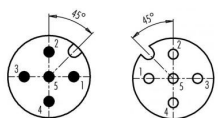

Mastkabel für Gabelstapler M12A/5p +2x offene Litzen  
*Mast cable for Forklift M12A/5p + 2x open wire*

3020146	AVS-Cable 30.8	▪ Länge 8 Meter	▪ <i>Length 8 Meter</i>
3020143	AVS-Cable 30.10	▪ Länge 10 Meter	▪ <i>Length 10 Meter</i>
3020146	AVS-Cable 30.12	▪ Länge 12 Meter	▪ <i>Length 12 Meter</i>
3020143	AVS-Cable 30.13	▪ Länge 13 Meter	▪ <i>Length 13 Meter</i>

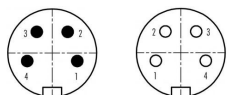

Verbindungskabel M16/4p  
*Connection cable M16/4p*

3020158	AVS-Cable 35.3	▪ Länge 3 Meter	▪ <i>Length 3 Meter</i>
---------	----------------	-----------------	-------------------------

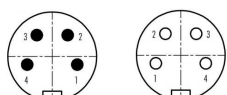

Schleppkettenkabel für Abfallsammelfahrzeuge M16/4p  
*Drag chain cable for waste collection vehicles M16/4p*

3020174	AVS-Cable 40.20	▪ Länge 20 Meter	▪ <i>Length 20 Meter</i>
---------	-----------------	------------------	--------------------------

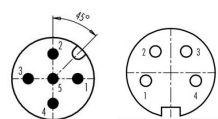

Adapter M12A-M-5p auf M16-F-4p  
*Adapter M12A-M-5p auf M16-F-4p*

3020176	AVS-Cable 41.2	▪ Länge 2 Meter	▪ <i>Length 2 Meter</i>
---------	----------------	-----------------	-------------------------

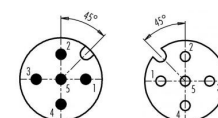

Mastkabel für Gabelstapler M12A/5p +6x offene Litzen  
*Mast cable for Forklift M12A/5p + 6x open wire*

3020177	AVS-Cable 42.10	▪ Länge 10 Meter	▪ <i>Length 10 Meter</i>
---------	-----------------	------------------	--------------------------

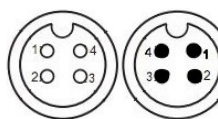

Mastkabel für Gabelstapler M12A/4p +6x offene Litzen  
*Mast cable for Forklift M12A/4p + 6x open wire*

3020178	AVS-Cable 43.10	▪ Länge 10 Meter	▪ <i>Length 10 Meter</i>
3020179	AVS-Cable 43.12	▪ Länge 12 Meter	▪ <i>Length 12 Meter</i>

## Stecker Selbstmontage / *Connector Self assembly*



M12A kodiert 5p für Selbstmontage

*M12A coded 5p for Self assembly*



1040007	M12-M-A-5p shielded	▪ Kabel Ø 8-10mm	▪ <i>Cabel Ø 8-10mm</i>
1040008	M12-F-A-5p shielded	▪ Kabel Ø 8-10mm	▪ <i>Cabel Ø 8-10mm</i>
1040011	M12-F-A-5p unshielded	▪ Kabel Ø 6-8mm	▪ <i>Cabel Ø 6-8mm</i>
1040012	M12-F-A-5p unshielded	▪ Kabel Ø 4-6mm	▪ <i>Cabel Ø 4-6mm</i>
1040013	M12-M-A-5p unshielded	▪ Kabel Ø 6-8mm	▪ <i>Cabel Ø 6-8mm</i>
1040014	M12-M-A-5p unshielded	▪ Kabel Ø 4-6mm	▪ <i>Cabel Ø 4-6mm</i>
1040017	M12-F-A-5p shielded 6-8mm	▪ Kabel Ø 6-8mm	▪ <i>Cabel Ø 6-8mm</i>
1040018	M12-M-A-5p shielded 6-8mm	▪ Kabel Ø 4-6mm	▪ <i>Cabel Ø 4-6mm</i>
1040019	M12-M-A-5p shielded 6-8mm	▪ Kabel Ø 6-8mm	▪ <i>Cabel Ø 6-8mm</i>
1040020	M12-M-A-5p shielded 4-6mm	▪ Kabel Ø 4-6mm	▪ <i>Cabel Ø 4-6mm</i>



RD24/7p für Selbstmontage

*RD24/7p for Self assembly*

1040015	RD24-M-7p-PG9 unshielded	▪ Kabel Ø 6-8mm	▪ <i>Cabel Ø 6-8mm</i>
1040016	RD24-F-7p-PG9 unshielded	▪ Kabel Ø 6-8mm	▪ <i>Cabel Ø 6-8mm</i>



M16/4p für Selbstmontage

*M16/4p for Self assembly*



1040021	M16-M-4p unshielded 4-6mm	▪ Kabel Ø 4-6mm	▪ <i>Cabel Ø 4-6mm</i>
1040022	M16-F-4p unshielded 4-6mm	▪ Kabel Ø 4-6mm	▪ <i>Cabel Ø 4-6mm</i>
1040029	M16-M-4p shielded 6-8mm	▪ Kabel Ø 6-8mm	▪ <i>Cabel Ø 6-8mm</i>
1040030	M16-F-4p shielded 6-8mm	▪ Kabel Ø 6-8mm	▪ <i>Cabel Ø 6-8mm</i>

## Zubehör / Accessories

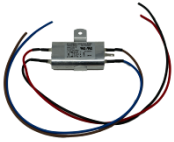

3040022	Ark-ACC-EF102	▪ Entstörfilter	▪ <i>Interference filter</i>
---------	---------------	-----------------	------------------------------



Potentialtrennung / *Galvanic separation*  
80/48V DC auf 24V DC / 80/48V DC to 24V DC

3040025	Ark-ACC-DC-Converter 80/48-24	▪ Spannungswandler	▪ <i>Power Supply Converter</i>
---------	----------------------------------	--------------------	---------------------------------



48V DC auf 12V DC / *48V DC to 12V DC*

3040032	Ark-ACC-DC-Converter 48-12	▪ Spannungswandler	▪ <i>Power Supply Converter</i>
---------	-------------------------------	--------------------	---------------------------------



3040028	Ark-ACC-PS	▪ Umlenkrolle (92mm)	▪ <i>Pulley Set (92mm)</i>
3040039	Ark-ACC-PS-1	▪ Umlenkrolle (75mm)	▪ <i>Pulley Set (75mm)</i>



Zugentlastungsset für Mastkabel AVS-Cable 14.x oder 15.x  
*Strain relief set for mast cable AVS-Cable 14.x or 15.x*  
Lieferumfang 2x Zugentlastungsset / *Scope of delivery 2x Strain relief set*

3040027	Ark-ACC-MSZ	▪ Zugentlastungsset	▪ <i>Strain relief set</i>
---------	-------------	---------------------	----------------------------



Spiralkabel-Zugentlastungsset für AVS-Cable 7.x  
*Spiral cable strain relief set for AVS-Cable 7.x*  
Lieferumfang 2x Zugentlastung / *Scope of delivery 2x Strain relief set*

3040040	Ark-ACC-SZS	▪ Spiralkabel-Zugentlastungsset	▪ <i>Spiral cable strain relief set</i>
---------	-------------	---------------------------------	---

<sup>1</sup> Auf Anfrage

Es gelten die Standardlieferzeiten von 5-7 Werktagen - Irrtum und Zwischenverkauf vorbehalten.

<sup>1</sup> On request

Standard delivery times of 5-7 business days apply - subject to errors and prior sale.

**Monitor mit Quad Funktion / Monitor with Quad View**

Mögliche Bildansichten

*Possible Picture view*

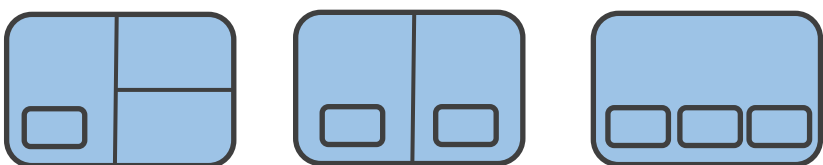
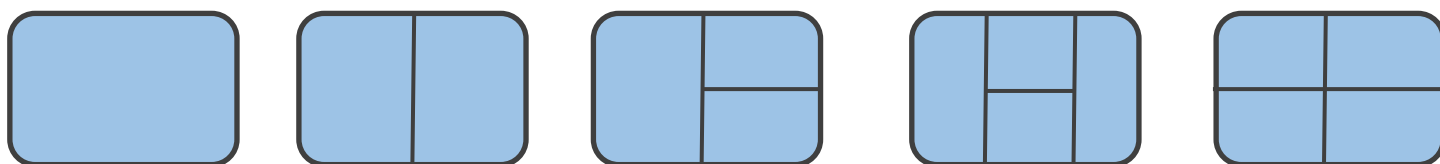

**PIP Mode (Picture in Picture)**

PIP frei konfigurierbar /

*PIP freely configurable*



**SP Mode**

Alle vier Kamerabilder können frei konfiguriert werden /

*All four camera pictures can be freely configured*

**Stromversorgung / Power supply**

Monitore 10-32V DC

Kameras / Cameras 12V DC

Wireless 10-32V DC

Control Unit 10-32V DC

DVR 10-32V DC



**Bildwinkel / Viewing angle**

Angegeben Bildwinkel sind immer horizontal

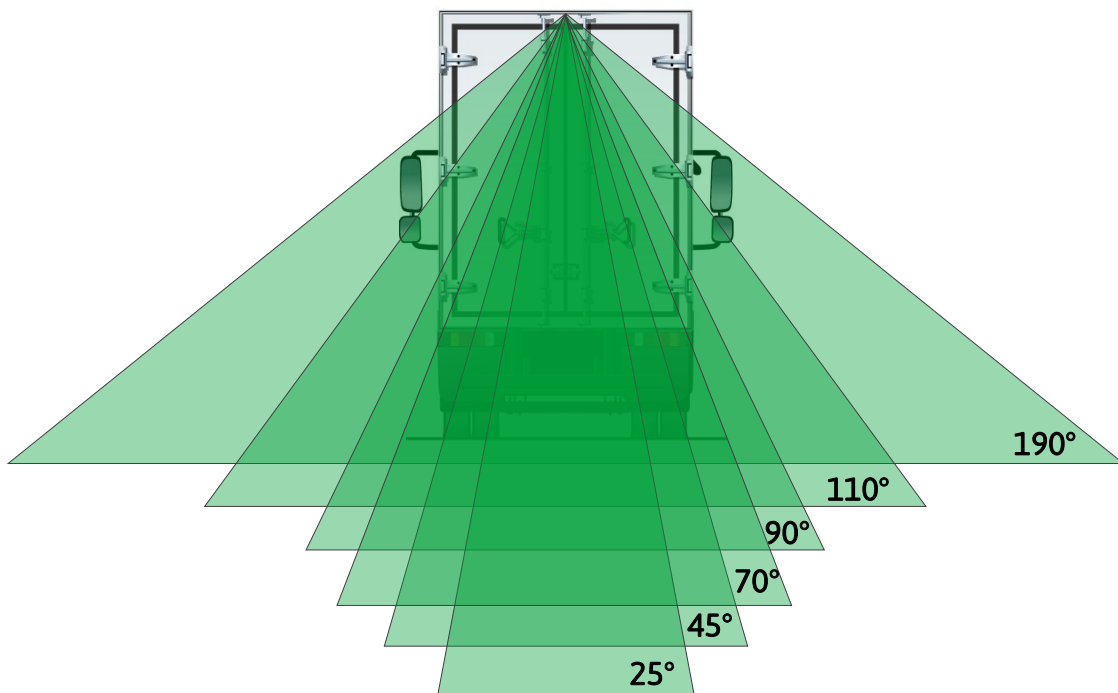

*Specified viewing angle are always horizontal*

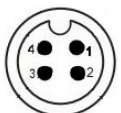

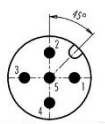

Stecker / Connector

		M12A-M-4p = M12 A-kodiert, Stecker, 4p, IP67 <i>M12A-M-4p = M12 A-coded, Male, 4p, IP67</i>
		M12A-F-4p = M12 A-kodiert, Buchse, 4p, IP67 <i>M12A-F-4p = M12 A-coded, Female, 4p, IP67</i>

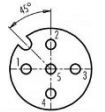
Ark Vision Systems

		M12A-M-5p = M12 A-kodiert, Stecker, 5p, IP67 <i>M12A-M-5p = M12 A-coded, Male, 5p, IP67</i>
		M12A-F-5p = M12 A-kodiert, Buchse, 5p, IP67 <i>M12A-F-5p = M12 A-coded, Female, 5p, IP67</i>

Motec

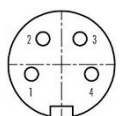
		M16-M-4p = M16, Stecker, 4p, IP67 <i>M16-M-4p = M16, Male, 4p, IP67</i>
		M16-F-4p = M16, Stecker, 4p, IP67 <i>M16-F-4p = M12, Male, 4p, IP67</i>

Orlaco

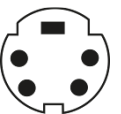
		MiniDIN-M-4p = MiniDIN, Stecker, 4p, IP30 <i>MiniDIN-M-4p = MiniDIN, Male, 4p, IP30</i>
		MiniDINW-F-4p = MiniDIN, Buchse, 5p, W=IP67 <i>MiniDINW-F-4p = MiniDIN, Female, 5p, W=IP67</i>
		MiniDINW-M-4p = MiniDIN, Stecker, 4p, IP30 <i>MiniDINW-M-4p = MiniDIN, Male, 4p, IP30</i>

Brigade / Motec

